





## BQ22..

	<b>MANUALE ISTRUZIONI</b>	SCALDABAGNO NAUTICO BQ22.. CON DOPPIO RISCALDAMENTO: RISCALDAMENTO ELETTRICO E RISCALDAMENTO INDIRECTO (SMALTATO)
	<b>INSTRUCTION MANUAL</b>	MARINE WATER HEATER BQ22.. WITH DUAL HEATING AS STANDARD: ELECTRICAL HEATING AND INDIRECT HEATING (ENAMELLED)
	<b>MANUAL DE INSTRUCCIONES</b>	CALENTADOR DE AGUA PARA EMBARCACIONES BQ22.. CON DOBLE CALEFACCIÓN: CALENTAMIENTO ELÉCTRICO E INDIRECTO (ESMALTADO)
	<b>MANUEL D'UTILISATION</b>	CHAUFFE-EAU POUR BATEAUX BQ22.. AVEC DOUBLE CHAUFFAGE: CHAUFFAGE ELECTRIQUE ET CHAUFFAGE INDIRECT (ÉMAILLÉ)

 <p>La gamma di scaldacqua <b>BQ22..</b> comprende 3 differenti modelli disponibili con le seguenti caratteristiche per soddisfare ogni esigenza di installazione e di utilizzo</p> <p>a) 1 capacità di stoccaggio (22 litri / 5,8 galloni) b) 3 potenze (550 W – 850 W – 1250 W)</p>	 <p>The water heaters mod. <b>BQ22..</b> include 3 different models with the following features to satisfy every installation and use requirement</p> <p>a) 1 storage capacity (22 litres / 5,8 gallons) b) 3 powers (550 W – 850 W – 1250 W)</p>
 <p>La gama de calentadores de agua <b>BQ22..</b> incluye 3 modelos diferentes con características que cumplen todos los requisitos de instalación y uso:</p> <p>a) 1 capacidad de almacenamiento (22 litros / 5,8 galones) b) 3 potencias (550 W – 850 W – 1250 W)</p>	 <p>La gamme de chauffe-eau <b>BQ22..</b> comprend 3 modèles différents ayant les caractéristiques suivantes, pour satisfaire toutes les exigences d'installation et d'utilisation</p> <p>a) 1 capacité de stockage (22 litres / 5,8 gallons) b) 3 puissances (550 W – 850 W – 1250 W)</p>

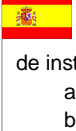
## 1. PRECAUZIONI GENERALI

### GENERAL PRECAUTIONS

### PRECAUCIONES GENERALES



### PRÉCAUTIONS GÉNÉRALES

 Le istruzioni che seguono sono importanti per garantire la sicurezza di installazione, uso e manutenzione dell'apparecchio.

- Questo libretto è parte integrante ed essenziale del riscaldatore di acqua: quindi deve essere tenuto a portata di mano per ogni ulteriore consultazione.
- Il riscaldatore d'acqua è stato prodotto per la produzione di acqua calda: qualsiasi altro tipo di utilizzo è da considerarsi pericoloso e non idoneo.
- L'installazione deve essere effettuata da una persona qualificata, che è responsabile per l'applicazione delle norme di sicurezza vigenti. L'installazione impropria, causata dal mancato rispetto delle istruzioni fornite dal produttore, può causare lesioni a persone, animali o danni ad altre apparecchiature per le quali il costruttore declina ogni responsabilità.
- Prima di collegare lo scaldabagno, assicurarsi che le caratteristiche elettriche stampate sulla targhetta dati corrispondano a quelle della rete elettrica.
- Se lo scaldabagno è installato in un bagno, in una stanza umida o vicino all'acqua, prendersi cura delle distanze di sicurezza previste dalla normativa CEI-CEE. Inoltre, interruttori o qualsiasi altro comando elettrico non devono essere raggiungibili da chiunque stia facendo una doccia o utilizzando la vasca da bagno. Non toccare l'apparecchio con mani bagnate o umide.
- Non consentire l'utilizzo da parte di bambini o persone incapaci senza alcun controllo.
- Le parti di imballaggio (sacchetti di plastica, polistirolo, clip, ecc.) devono essere tenute lontane dai bambini, perché possono essere pericolose.
- Leggere attentamente questo libretto in quanto fornisce istruzioni utili in materia di sicurezza, d'installazione, uso e manutenzione.
- Se l'apparecchio dovesse essere venduto o spostato ad altro proprietario, assicurarsi che il presente libretto accompagni l'apparecchio, in modo che il nuovo proprietario e / o l'installatore possano consultarlo.
- Per evitare il rischio di danni dovuti al gelo, se l'apparecchio non viene utilizzato per un lungo periodo ed è installato in un locale non riscaldato, si consiglia di svuotarlo completamente. Il produttore non è responsabile di eventuali danni o rotture dovute al gelo o perdite di acqua dall'impianto.
- Per ottenere le migliori prestazioni dal riscaldamento dell'acqua e per scopi di garanzia, rispettare rigorosamente le istruzioni riportate in questo manuale.

 The following instructions are important to ensure the safe installation, use and maintenance of the appliance.

- This booklet is an integral and essential part of the water heater: therefore, it must be kept at hand for any further consultation.
- The water heater has been produced for the production of hot water: any other type of use has to be considered dangerous and unsuitable.
- The installation must be carried out by a qualified person who is responsible for the application of the safety regulations in force. Improper installation, caused by failure to comply with the manufacturer's instructions, can cause injury to people, animals or damage to other equipment, which the manufacturer declines all responsibility for.
- Before connecting the water heater, make sure that the electrical characteristics printed on the data plate correspond to those of the mains.
- If the water heater is installed in a bathroom, in a damp room or near water, take care of the safety distances provided for by the CEI-EEC regulations. Furthermore, switches or any other electrical controls must not be reachable by anyone taking a shower or using the bathtub. Do not touch the appliance with wet or damp hands.
- Do not allow use by children or incapable persons without any supervision.
- Packaging parts (plastic bags, polystyrene, clips, etc.) must be kept away from children, as they can be dangerous.
- Read this booklet carefully, as it provides useful instructions on safety, installation, use and maintenance.
- If the appliance is sold or transferred to another owner, make sure that this manual accompanies the appliance, so that the new owner and / or installer can consult it.
- To avoid the risk of damage due to frost, if the appliance is not used for a long period and is installed in an unheated room, it is recommended to empty it completely. The manufacturer is not responsible for any damage or breakages due to frost or for water leaks from the system.
- For best water heating performance and for warranty purposes, strictly adhere to the instructions included in this manual.

 <p>Las siguientes instrucciones son importantes para garantizar la instalación, el uso y el mantenimiento del aparato en modo seguro.</p> <ul style="list-style-type: none"> <li>• Este folleto es una parte integral y esencial del calentador de agua: por lo tanto debe tenerlo a la mano para cualquier consulta posterior.</li> <li>• El calentador de agua se ha fabricado para la producción de agua caliente: cualquier otro tipo de uso debe considerarse peligroso e inadecuado.</li> <li>• La instalación debe ser realizada por una persona cualificada responsable de la aplicación de las normas de seguridad vigentes. La instalación incorrecta, causada por el incumplimiento de las instrucciones del fabricante, puede causar lesiones a personas, animales o daños a otros equipos por los cuales el fabricante declina toda responsabilidad.</li> <li>• Antes de conectar el calentador de agua, asegúrese de que las características eléctricas impresas en la placa de datos sean compatibles con las de la red eléctrica.</li> <li>• Si el calentador de agua se instala en un baño, en una habitación húmeda o cerca del agua, tenga en cuenta las distancias de seguridad previstas por la normativa CEI-EEC. Además, los interruptores o cualquier otro control eléctrico no deben estar al alcance de cualquier persona que se bañe o use la bañera. No toque el aparato con las manos mojadas o húmedas.</li> <li>• No permita que los niños o personas discapacitadas lo utilicen sin supervisión.</li> <li>• Las piezas de embalaje (bolsas de plástico, poliestireno, clips, etc.) deben mantenerse alejadas de los niños, ya que pueden ser peligrosas.</li> <li>• Lea este folleto con atención, ya que proporciona instrucciones útiles sobre seguridad, instalación, uso y mantenimiento.</li> <li>• Si el aparato se vende o se transfiere a otro propietario, asegúrese de que este folleto acompañe al aparato, para que el nuevo propietario y / o el instalador puedan consultarlo.</li> <li>• Para evitar el riesgo de daños por heladas, si el aparato no se utiliza durante un periodo prolongado y se instala en una habitación sin calefacción, se recomienda vaciarlo por completo. El fabricante no se hace responsable de ningún daño o rotura debido a heladas o fugas de agua del sistema.</li> <li>• Para obtener el mejor rendimiento de calentamiento de agua y para fines de garantía, siga estrictamente las instrucciones de este manual.</li> </ul>	 <p>Les instructions suivantes sont importantes pour garantir une installation, une utilisation et un entretien sûrs de l'appareil.</p> <ul style="list-style-type: none"> <li>• Ce livret fait partie intégrante et indispensable du chauffe-eau: il doit donc être conservé à portée de main pour toute consultation ultérieure.</li> <li>• Le chauffe-eau a été conçu pour la production d'eau chaude: tout autre type d'utilisation est à considérer comme dangereux et inapproprié.</li> <li>• L'installation doit être réalisée par une personne qualifiée responsable de l'application des règles de sécurité en vigueur. Une mauvaise installation, causée par le non-respect des instructions du fabricant, peut causer des blessures aux personnes et animaux ou des dommages à d'autres équipements pour lesquels le fabricant décline toute responsabilité.</li> <li>• Avant de brancher le chauffe-eau, assurez-vous que les caractéristiques électriques imprimées sur la plaque signalétique correspondent à celles du réseau électrique.</li> <li>• Si le chauffe-eau est installé dans une salle de bain, dans une pièce humide ou à proximité de l'eau, respecter les distances de sécurité prévues par la norme CEI-CEE. De plus, les interrupteurs ou toute autre commande électrique ne doivent pas être accessibles par toute personne prenant une douche ou utilisant la baignoire. Ne pas toucher l'appareil avec les mains mouillées ou humides.</li> <li>• Ne pas permettre l'utilisation par des enfants ou des personnes incapables sans aucune surveillance.</li> <li>• Les pièces d'emballage (sacs en plastique, polystyrène, clips, etc.) doivent être tenues hors de portée des enfants, car elles peuvent être dangereuses.</li> <li>• Lire attentivement ce livret car il fournit des instructions utiles sur la sécurité, l'installation, l'utilisation et la maintenance.</li> <li>• Si l'appareil est vendu ou transféré à un autre propriétaire, s'assurer que ce livret accompagne l'appareil, afin que le nouveau propriétaire et / ou l'installateur puissent le consulter.</li> <li>• Pour éviter les risques de dommages dus au gel, si l'appareil n'est pas utilisé pendant une longue période et est installé dans une pièce non chauffée, il est recommandé de le vider complètement. Le fabricant n'est pas responsable des dommages ou bris dus au gel ou aux fuites d'eau du système.</li> <li>• Pour des meilleures performances de chauffage de l'eau et à des fins de garantie, respecter strictement les instructions dans ce manuel.</li> </ul>
---	---

**2.  CARATTERISTICHE TECNICHE**  
** TECHNICAL FEATURES**  
** CARACTERÍSTICAS TÉCNICAS**  
** CARACTÉRISTIQUES TECHNIQUES**

		BQ2205	BQ2208	BQ2212
Aliment. elettrica <i>Electrical supply</i>	V~	230	230	230
	A	2,4	3,7	5,4
Potenza <i>Power</i>	W	550	850	1.250
Capacità <i>Capacity</i>	l ( gal )	22 ( 5,8 )		
Pressione massima <i>Max pressure</i>	kPa ( psi )	600 ( 87 )		
Peso a vuoto <i>Empty weight</i>	kg ( lb )	13,9 ( 30,6 )		
Dimensioni <i>Dimensions</i>	mm ( inch )	320 x 320 x 619 ( 12,6 x 12,6 x 24,4 )		

3. **CONTENUTO IMBALLO**  
**PACKAGING CONTENTS**  
**CONTENIDO DEL EMBALAJE**  
**CONTENU DE L'EMBALLAGE**

L'apparecchio è confezionato e consegnato in una scatola di cartone con una protezione adeguata. Oltre all'apparecchio, all'interno della scatola è presente il manuale di installazione



The device is packaged and delivered in a cardboard box with adequate protection. In addition to the appliance, inside the box there is the installation manual



El aparato se embala y entrega en una caja de cartón con la protección adecuada. Además del aparato, dentro de la caja encontrará el manual de instalación



L'appareil est emballé et livré dans une boîte en carton avec une protection adéquate. En plus de l'appareil, il y a à l'intérieur de la boîte le manuel d'installation

4. **DIMENSIONI**  
**DIMENSIONS**  
**MEDIDAS**  
**DIMENSIONS**

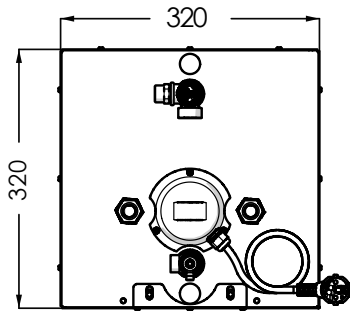
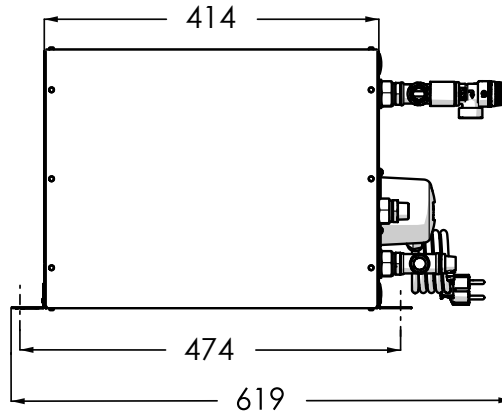

FIG-00303



**5. DESCRIZIONE COSTRUTTIVA E FUNZIONAMENTO**  
**CONSTRUCTION AND OPERATION DESCRIPTION**  
**DESCRIPCIÓN DE LA CONSTRUCCIÓN Y FUNCIONAMIENTO**  
**DESCRIPTION DE LA CONSTRUCTION ET DU FONCTIONNEMENT**

**BQ22..**  
 Lo scopo di questo apparecchio è di riscaldare l'acqua calda sanitaria in due modi diversi:

- attraverso lo scambio di calore tra l'acqua di raffreddamento del motore e l'acqua immagazzinata nel serbatoio. Tale scambio termico è possibile grazie ad uno scambiatore di calore. L'acqua di raffreddamento del motore circola attraverso uno scambiatore di calore posto al centro del serbatoio per diffondere uniformemente il calore.
- per mezzo di una resistenza elettrica (fornita di serie con l'apparecchio).

**BQ22..**  
 The purpose of this appliance is to heat the domestic water in two different ways:

- through the heat exchange between the engine cooling water and the water stored in the tank. This heat exchange is possible thanks to a heat exchanger. The engine cooling water circulates through one heat exchanger located in the centre of the tank to spread the heat evenly.
- by means of an electric heating element (supplied as standard with the appliance).

**BQ22..**  
 El propósito de este aparato es calentar el agua caliente sanitaria de dos formas diferentes:

- mediante el intercambio de calor entre el agua de refrigeración del motor y el agua almacenada en el depósito. Este intercambio de calor es posible gracias a un intercambiador de calor. El agua de refrigeración del motor circula a través de un intercambiador de calor ubicado en el centro del tanque para distribuir el calor de manera uniforme.
- mediante resistencia eléctrica (suministrada de serie con el aparato).

**BQ22..**  
 Le but de cet appareil est de chauffer l'eau sanitaire de deux manières différentes:

- par l'échange de chaleur entre l'eau de refroidissement du moteur et l'eau stockée dans le réservoir. Cet échange thermique est possible grâce à un échangeur de chaleur. L'eau de refroidissement du moteur circule à travers un échangeur de chaleur situé au centre du réservoir pour répartir uniformément la chaleur.
- au moyen d'une résistance électrique (fournie en standard avec l'appareil).

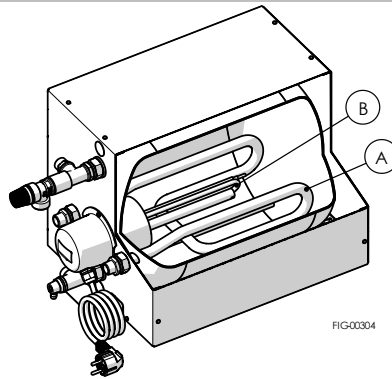

**Parti principali:**

1. Serbatoio di stoccaggio: è interamente realizzato in acciaio smaltato.
2. Mantello esterno: resistente agli urti e alle sollecitazioni esterne, con finitura superficiale di alto livello estetico.
3. Isolamento termico: realizzato in poliuretano espanso a cellule chiuse, evita inutili perdite di calore. In questo modo la perdita di calore per inerzia termica è ridotta a 1 °C ogni ora per un periodo di 24 ore.
4. Scambiatore di calore: è realizzato in acciaio smaltato. La sua superficie di scambio permette di sfruttare al meglio il calore dell'acqua di raffreddamento del motore e di ottenere acqua calda anche in condizioni estreme.
5. Resistenza elettrica: l'apparecchio è dotato di un elemento riscaldante elettrico (550 W – 850 W –1250 W, 230V ~) per riscaldare l'acqua anche quando il motore della barca è spento (per esempio quando la barca è in banchina). Materiale: lega INCOLOY resistente alla corrosione.
6. Termostato: ha due funzioni, precisamente:
  - a. Regolazione della temperatura: interrompe l'alimentazione elettrica all'elemento riscaldatore al raggiungimento della temperatura preimpostata (la temperatura può essere regolata tra 13 °C e 65 °C, secondo le esigenze dell'utente).
  - b. Sicurezza: interrompe l'alimentazione elettrica all'elemento riscaldatore quando, in caso di cattivo funzionamento dell'apparecchio, la temperatura dell'acqua raggiunge 83 °C. È necessario un intervento manuale per far ripartire l'apparecchio (reset manuale).



Range di temperatura: da 13 °C a 65 °C  
Temperatura di sicurezza: 83 °C  
Corrente massima: 16 A
7. Ingresso acqua fredda
8. Connessioni idrauliche dello scambiatore di calore
9. Uscita acqua calda
10. Valvola di sicurezza combinata pressione e temperatura. Taratura:
  1. Pressione: 700 kPa (101,5 psi) conforme a norma EN1490
  2. Temperatura: 92 ± 3 °C
11. Staffe di fissaggio
12. Anodo in magnesio
13. Rubinetto di scarico



**Main parts:**

1. Storage tank: it is entirely made of enamelled steel.
2. Outer casing: resistant to shocks and external stresses, with a high aesthetic level surface finish.
3. Thermal insulation: it is made of closed cell polyurethane foam and avoids unnecessary heat loss. In this way the heat loss due to thermal inertia is reduced to 1 °C every hour, for a period of 24 hours.
4. Heat exchanger: it is made of enamelled steel. Its exchange surface makes it possible to make the most of the heat from the engine cooling water and to obtain hot water even in extreme conditions.
5. electric heating element: the appliance is equipped with an electric heating element (550 W – 850 W –1250 W, 230V ~) to heat the water even when the boat's engine is off (for example when the boat is at the quay). Material: corrosion resistant INCOLOY alloy.
6. Thermostat: it has two functions, namely:
  - a. Temperature regulation: it interrupts the power supply to the heater element when the preset temperature is reached (the temperature can be adjusted between 13 °C and 65 °C, according to the user's needs).
  - b. Safety: it cuts off the power supply to the heating element when, in the event of a failure of the appliance, the water temperature reaches 83 °C. Manual intervention is required to restart the appliance (manual reset).



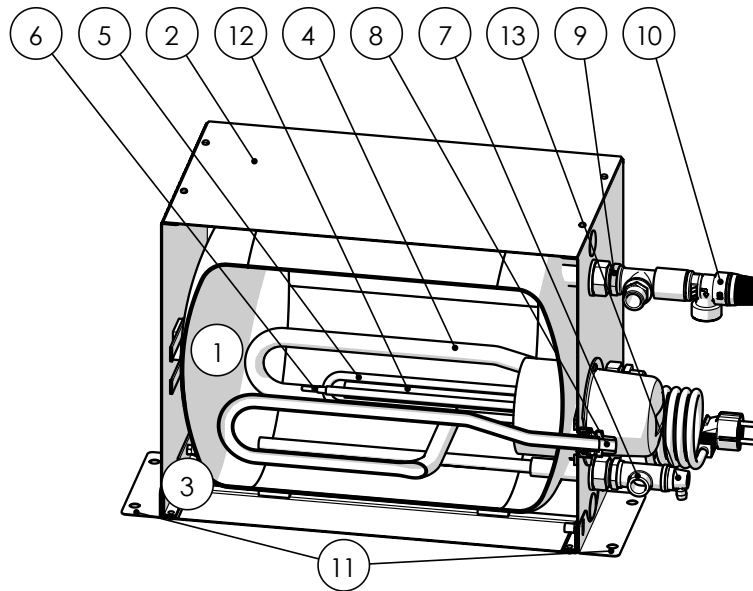

Temperature range: from 13 °C to 65 °C  
Safety temperature: 83 °C  
Maximum current: 16 A
7. Cold water inlet
8. Heat exchanger hydraulic connections
9. Hot water outlet
10. Pressure and temperature relief valve. Calibration:
  1. Pressure: 700 kPa (101,5 psi) in accordance with Standard EN1490
  2. Temperature: 92 ± 3 °C
11. Fixing brackets
12. Magnesium anode
13. Drain tap





	<p><b>Partes principales:</b></p> <ol style="list-style-type: none"> <li>1. Tanque de almacenamiento: está fabricado completamente en acero esmaltado.</li> <li>2. Capa exterior: resistente a los golpes y tensiones externas, con un acabado superficial de alto nivel estético.</li> <li>3. Aislamiento térmico: fabricado con espuma de poliuretano de celda cerrada, evita pérdidas de calor innecesarias. De esta manera, la pérdida de calor por inercia térmica se reduce a 1 °C cada hora durante un período de 24 horas.</li> <li>4. Intercambiador de calor: está fabricado en acero esmaltado. Su superficie de intercambio permite aprovechar al máximo el calor del agua de refrigeración del motor y obtener agua caliente incluso en condiciones extremas.</li> <li>5. Calentador eléctrico: el aparato está equipado con un elemento calefactor eléctrico (550 W – 850 W –1250 W, 230V ~) para calentar el agua incluso cuando el motor del barco está parado (por ejemplo, cuando el barco está en el muelle). Material: aleación INCOLOY resistente a la corrosión.</li> <li>6. Termostato: tiene las siguientes funciones:             <ol style="list-style-type: none"> <li>a. Regulación de la temperatura: corta la alimentación del elemento calefactor cuando se alcanza la temperatura preestablecida (la temperatura se puede regular entre 13 °C y 65 °C, según las necesidades del usuario).</li> <li>b. Seguridad: corta el suministro eléctrico a la resistencia cuando, en caso de mal funcionamiento del aparato, la temperatura del agua alcanza los 83 °C. Se requiere intervención manual para reiniciar el aparato (reinicio manual).</li> </ol> <p>Rango de temperatura: de 13 °C a 65 °C              Temperatura de seguridad: 83 °C              Corriente máxima: 16 A</p> </li> <li>7. Entrada de agua fría</li> <li>8. Conexiones hidráulicas de l'intercambiador de calor</li> <li>9. Salida de agua caliente</li> <li>10. Válvula de seguridad combinada de temperatura y presión. Calibración:             <ol style="list-style-type: none"> <li>1. Presión: 700 kPa (101,5 psi) según la EN1490</li> <li>2. Temperatura: 92 ± 3 °C</li> </ol> </li> <li>11. Barras de fijación</li> <li>12. Ánodo de magnesio</li> <li>13. Válvula de cierre de descarga</li> </ol>		<p><b>Pièces principales (voir FIG_5-2.):</b></p> <ol style="list-style-type: none"> <li>1. Réservoir de stockage: il est entièrement réalisé en acier émaillé.</li> <li>2. Revêtement extérieur: résistant aux chocs et aux contraintes extérieures, avec une finition de haut niveau esthétique.</li> <li>3. Isolation thermique: en mousse de polyuréthane à cellules fermées, elle évite les pertes de chaleur inutiles. De cette manière, la perte de chaleur due à l'inertie thermique est réduite à 1 °C toutes les heures pendant une période de 24 heures.</li> <li>4. Échangeur de chaleur: il est en acier émaillé. Sa surface d'échange permet d'exploiter aux mieux la chaleur de l'eau de refroidissement du moteur et d'obtenir de l'eau chaude même dans des conditions extrêmes.</li> <li>5. Chauffage électrique: l'appareil est équipé d'un élément chauffant électrique (550 W – 850 W –1250 W, 230V ~) pour chauffer l'eau même lorsque le moteur du bateau est éteint (par exemple lorsque le bateau est à quai). Matériau: alliage INCOLOY résistant à la corrosion.</li> <li>6. Thermostat: a deux fonctions, à savoir:             <ol style="list-style-type: none"> <li>a. Régulation de la température: il coupe l'alimentation électrique de l'élément chauffant lorsque la température prééglée est atteinte (la température peut être réglée entre 13 °C et 65 °C, selon les besoins de l'utilisateur).</li> <li>b. Sécurité: il coupe l'alimentation électrique de l'élément chauffant lorsque, en cas de dysfonctionnement de l'appareil, la température de l'eau atteint 83 °C. Une intervention manuelle est nécessaire pour redémarrer l'appareil (réinitialisation manuelle).</li> </ol> <p>plage de température: de 13 °C à 65 °C              Température de sécurité: 83 °C              Courant maximum: 16 A</p> </li> <li>7. Entrée eau froide</li> <li>8. Raccordements hydrauliques de l'échangeur de chaleur</li> <li>9. Sortie eau chaude</li> <li>10. Soupape de sécurité combinée pression et température. Étalonnage:             <ol style="list-style-type: none"> <li>1. Pression: 700 kPa (101,5 psi) conformément à la norme EN1490</li> <li>2. Température: 92 ± 3 °C</li> </ol> </li> <li>11. Brides de fixation</li> <li>12. Anode en magnésium</li> <li>13. Robinet de vidange</li> </ol>
---	---	--	--







6.  **ISTRUZIONI DI INSTALLAZIONE**  
 **INSTALLATION INSTRUCTIONS**  
 **INSTRUCCIONES DE INSTALACIÓN**  
 **INSTRUCTIONS D'INSTALLATION**



<p> • L'installazione deve essere effettuata, in conformità con la normativa vigente, da una persona qualificata in grado di eseguire non solo un set up corretto dell'apparecchio, ma anche le prove necessarie prima di iniziare il riscaldamento dell'acqua.</p> <p>• Durante l'installazione originale o successiva manutenzione, seguire le istruzioni riportate in questo libretto con attenzione. Modifiche a qualsiasi tipo di connessione o la mancata osservanza delle istruzioni fornite causerà la decadenza della garanzia.</p> <p>• Prima dell'installazione, manutenzione o riparazione, togliere l'alimentazione elettrica all'apparecchio.</p>	<p> • The installation must be carried out, in compliance with the current legislation, by a qualified person able to perform not only a correct set up of the appliance, but also the necessary tests before starting the water heating.</p> <p>• During original installation or subsequent maintenance, follow the instructions in this booklet carefully. Changes to any type of connection or failure to follow the instructions provided will cause the warranty to lapse.</p> <p>• Before installation, maintenance or repair, disconnect the appliance from the power supply.</p>
<p> • La instalación debe ser realizada, de acuerdo con la legislación vigente, por una persona cualificada capaz de realizar no solo una correcta instalación del aparato, sino también realizar las pruebas necesarias antes de iniciar el calentamiento del agua.</p> <p>• Durante la instalación original o el mantenimiento posterior, siga cuidadosamente las instrucciones de este folleto. Los cambios en cualquier tipo de conexión o el incumplimiento de las instrucciones proporcionadas harán que la garantía caduque.</p> <p>• Antes de la instalación, el mantenimiento o la reparación, desconecte el aparato de la corriente eléctrica.</p>	<p> • L'installation doit être réalisée, conformément à la législation en vigueur, par une personne qualifiée capable d'effectuer non seulement une mise en place correcte de l'appareil, mais également les tests nécessaires avant de démarrer le chauffage de l'eau.</p> <p>• Lors de l'installation d'origine ou d'une maintenance ultérieure, suivre attentivement les instructions de ce livret. Les modifications apportées à tout type de connexion ou le non-respect des instructions fournies entraîneront l'expiration de la garantie.</p> <p>• Avant l'installation, l'entretien ou la réparation, débrancher l'appareil de l'alimentation électrique.</p>

7.  **POSIZIONE E MONTAGGIO**  
 **POSITION AND ASSEMBLY**  
 **COLOCACIÓN Y MONTAJE**  
 **MISE EN PLACE ET MONTAGE**



<p> Sull'apparecchio sono presenti due staffe di fissaggio (vedere A in figura). In questo modo si ottiene un'installazione facile ma ferma e sicura.</p> <p>L'apparecchio deve essere installato conformemente a una delle tre posizioni (A, B, C) riportate in figura.</p> <p><b>ATTENZIONE: La posizione C è sconsigliata in quanto si riduce l'efficacia del riscaldamento.</b></p> <p>In generale, occorre fare in modo che lo scambiatore di calore e/o la resistenza elettrica siano posti nella parte inferiore.</p> <p>L'apparecchio può essere installato in qualsiasi spazio, senza limitazioni. Quanto sopra descritto non esime dal rispettare le istruzioni fornite nel paragrafo "Precauzioni generali", all'inizio di questo opuscolo.</p>	<p> The appliance is equipped with two fixing brackets (see A in picture). In this way an easy but firm and safe installation is obtained.</p> <p>The appliance must be installed in accordance with one of the three positions (A, B, C) shown in the picture.</p> <p><b>ATTENTION: Position C is not recommended because the heating efficiency is reduced.</b></p> <p>Generally, it is necessary to ensure that the heat exchanger and / or the electric heating element are placed in the lower part.</p> <p>The appliance can be installed in any space, without limitations. The above does not exempt from observing the instructions provided in the paragraph "General precautions" at the beginning of this booklet.</p>
<p> Hay dos soportes de fijación en el aparato (ver A in figura). De esta forma se consigue una instalación fácil pero firme y segura.</p> <p>El aparato debe instalarse siguiendo una de las tres posiciones presentadas (A, B, C) que se muestran en la figura.</p> <p><b>ATENCIÓN: No se recomienda la posición C ya que la eficiencia de calefacción se reduce.</b></p> <p>Generalmente, es necesario asegurarse de que el intercambiador de calor y / o la resistencia eléctrica estén colocados en la parte inferior.</p> <p>El aparato se puede instalar en cualquier espacio, sin limitaciones. Lo anterior no exime de seguir las instrucciones provistas en el párrafo "Precauciones generales" disponible al inicio de este folleto.</p>	<p> L'appareil est équipé de deux brides de fixation (voir A indiqué sur la figure). De cette manière, on obtient une installation facile mais ferme et sûre.</p> <p>L'appareil doit être installé conformément à l'une des trois positions (A, B, C) indiquées sur la figure.</p> <p><b>ATTENTION: La position C n'est pas recommandée parce que l'efficacité de chauffage est réduite.</b></p> <p>Généralement, il est nécessaire de s'assurer que l'échangeur de chaleur et / ou la résistance électrique sont placés dans la partie inférieure.</p> <p>L'appareil peut être installé dans n'importe quel endroit, sans limitation. Ce qui précède ne vous dispense pas de respecter les instructions fournies dans le paragraphe "Précautions générales" au début de ce livret.</p>



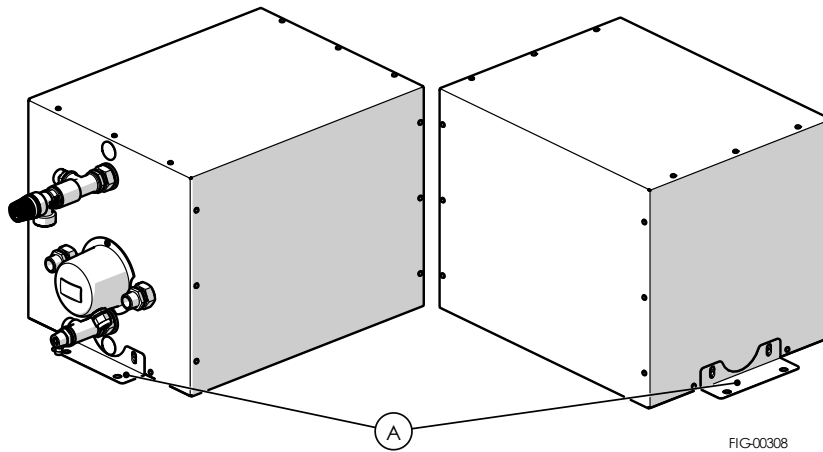

FIG-00308

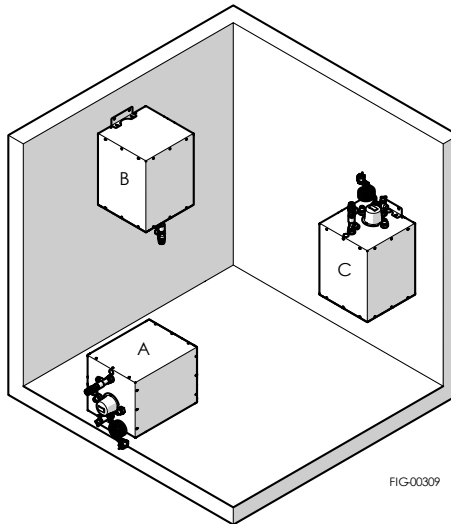

FIG-00309

**8. COLLEGAMENTI IDRAULICI E QUALITÀ DELL'ACQUA**  
**HYDRAULIC CONNECTIONS AND WATER QUALITY**  
**CONEXIONES HIDRÁULICAS Y CALIDAD DEL AGUA**  
**RACCORDEMENTS HYDRAULIQUES ET QUALITÉ DE L'EAU**



Per prolungare la durata dell'apparecchio, la qualità dell'acqua dovrebbe rispettare i seguenti parametri, come previsto dalla Direttiva Europea 98/83/CE (concernente la qualità delle acque destinate al consumo umano):

- durezza compresa tra 15 e 50 °F (in particolare, dove l'acqua ha subito un addolcimento o trattamento di desalinizzazione)
- cloruri compresi tra 25 e 100 mg/l
- PH compreso tra 6,5 e 9,5
- conducibilità compresa tra 400 e 1500 µS/cm

Collegare l'apparecchio secondo le seguenti indicazioni (vedere figura):

1. ingresso acqua fredda (1/2")
2. uscita acqua calda (1/2")
3. mandata acqua al circuito di raffreddamento del motore (1/2")
4. ritorno acqua dal circuito di raffreddamento del motore (1/2")

**ATTENZIONE: In caso di posizionamento C (per le considerazioni vedi paragrafo precedente) invertire gli attacchi acqua fredda/acqua calda, quindi:**

1. uscita acqua calda (1/2")
2. ingresso acqua fredda (1/2")

Pressione minima di ingresso dell'acqua: 70 kPa.

Si consiglia di isolare le condutture dell'acqua calda: si eviteranno così inutili sprechi di energia.

La valvola di sicurezza combinata pressione e temperatura è indicata con S in figura.

Il rubinetto di scarico è indicato con D in figura.

**ATTENZIONE: collegare lo scarico dell'acqua della valvola a un tubo di gomma. Questo tubo di scarico deve essere installato con una pendenza costante verso il basso e in un luogo protetto da ghiaccio.**

To extend the working life of the appliance, the quality of the water should comply with the following parameters, as required by the European Directive 98/83 / EC (concerning the quality of water intended for human consumption):

- hardness between 15 and 50°F (in particular, where the water has undergone a softening or desalination treatment)
- chlorides between 25 and 100 mg/l
- PH between 6.5 and 9.5
- conductivity between 400 and 1500 µS/cm

Connect the appliance according to the following indications (see picture):

1. cold water inlet (1/2")
2. hot water outlet (1/2")
3. water delivery to the engine cooling circuit (1/2")
4. water return from the engine cooling circuit (1/2")

**ATTENTION: In case of positioning C (for considerations see previous paragraph) reverse the cold water/hot water connections, so:**

1. hot water outlet (1/2")
2. cold water inlet (1/2")



Minimum water inlet pressure: 70 kPa.

It is advisable to insulate the hot water pipes: this will avoid unnecessary waste of energy.





Pressure and temperature relief valve is indicated with S in picture.

Drain tap is indicated with D in the picture.

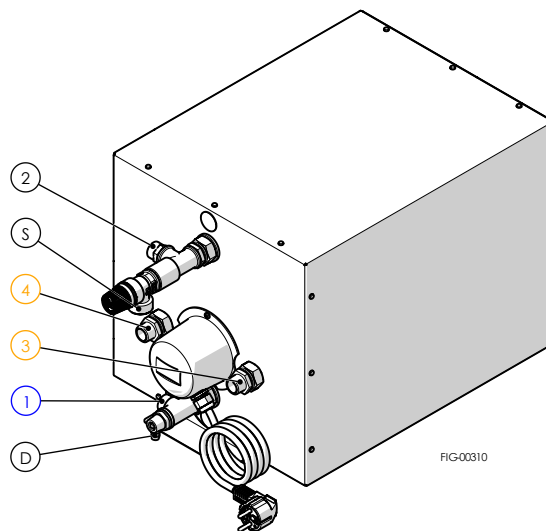
**ATTENTION: connect the water drain of the valve to a rubber hose. This drain pipe must be installed with a constant downward slope and in a place protected from ice.**

<p> Para aumentar la duración del aparato, la calidad del agua debe cumplir con los siguientes parámetros, tal como lo exige la Directiva europea 98/83 / CE (relativa a la calidad del agua destinada al consumo humano):</p> <ul style="list-style-type: none"> <li>• dureza entre 15 y 50 °F (en particular, cuando el agua ha sido sometida a un tratamiento de ablandamiento o desalinización)</li> <li>• cloruros entre 25 y 100 mg/l</li> <li>• PH entre 6.5 y 9.5</li> <li>• conductividad entre 400 y 1500 µS/cm</li> </ul> <p>Conecte el aparato de acuerdo con las siguientes indicaciones (ver figura):</p> <ol style="list-style-type: none"> <li>1. entrada de agua fría (1/2")</li> <li>2. salida de agua caliente (1/2")</li> <li>3. suministro de agua al circuito de refrigeración del motor (1/2")</li> <li>4. retorno de agua del circuito de refrigeración del motor (1/2")</li> </ol> <p><b>ATENCIÓN: En caso de posicionamiento C (Para consideraciones ver párrafo anterior) invertir las conexiones de agua fría/agua caliente, por lo tanto:</b></p> <ol style="list-style-type: none"> <li>1. salida de agua caliente (1/2")</li> <li>2. entrada de agua fría (1/2")</li> </ol> <p>Presión mínima de entrada de agua: 70 kPa.</p> <p>Es recomendable aislar las tuberías de agua caliente: esto evitará un derroche innecesario de energía.</p> <p>La válvula de seguridad combinada de temperatura y presión se indica con S in la figura.</p> <p>La válvula de cierre de descarga se indica con D in la figura.</p> <p><b>ATENCIÓN: conecte el drenaje de agua de la válvula a una manguera de goma. Esta tubería de drenaje debe instalarse con una pendiente descendente constante y en un lugar protegido del hielo.</b></p>	<p> Pour prolonger la durée de vie de l'appareil, la qualité de l'eau doit respecter les paramètres suivants, comme l'exige la directive européenne 98/83 / CE (concernant la qualité de l'eau destinée à la consommation humaine):</p> <ul style="list-style-type: none"> <li>• dureté entre 15 et 50 °F (en particulier, lorsque l'eau a subi un traitement d'adoucissement ou de dessalement)</li> <li>• chlorures entre 25 et 100 mg/l</li> <li>• PH entre 6,5 et 9,5</li> <li>• conductivité entre 400 et 1500 µS/cm</li> </ul> <p>Connecter l'appareil selon les indications suivantes (voir figure):</p> <ol style="list-style-type: none"> <li>1. entrée d'eau froide (1/2")</li> <li>2. sortie d'eau chaude (1/2")</li> <li>3. Alimentation en eau vers le circuit de refroidissement du moteur (1/2")</li> <li>4. Retour d'eau du circuit de refroidissement du moteur (1/2")</li> </ol> <p><b>ATTENTION: En cas de positionnement C (pour considérations voir paragraphe précédent) inverser les connexions eau froide/eau chaude, donc:</b></p> <ol style="list-style-type: none"> <li>1. sortie d'eau chaude (1/2")</li> <li>2. entrée d'eau froide (1/2")</li> </ol> <p>Pression minimale d'entrée d'eau: 70 kPa.</p> <p>Il est conseillé d'isoler les conduites d'eau chaude: cela évitera un gaspillage d'énergie inutile.</p> <p>La soupape de sécurité combinée pression et température est indiquée par S dans la figure.</p> <p>Le robinet de vidange est indiquée par D dans la figure.</p> <p><b>ATTENTION : raccorder la vidange d'eau de la vanne à un tuyau en caoutchouc. Ce tuyau d'évacuation doit être installé avec une pente descendante constante et dans un endroit protégé de la glace.</b></p>
---	---



9.  **COLLEGAMENTI ELETTRICI**  
 **ELECTRICAL CONNECTIONS**  
 **CONEXIONES ELÉCTRICAS**  
 **CONNEXIONS ÉLECTRIQUES**



 L'apparecchio deve essere collegato ad una alimentazione elettrica monofase (si prega di fare attenzione a collegare la corretta tensione: 120 V o 230 V secondo l'etichetta dati sull'apparecchio) e ad una buona connessione di terra.

 **IL COSTRUTTORE NON ACCETTA LA RESPONSABILITÀ PER DANNI POSSIBILI O LESIONI CAUSATI DALLA MANCANZA DI COLLEGAMENTO DI TERRA DELL'APPARECCHIO**

L'apparecchio è dotato di un cavo di alimentazione con spina Schuko. Collegare il cavo di alimentazione in conformità con le norme di cablaggio in vigore nel paese in cui è installato l'apparecchio. In caso di sostituzione del cavo di alimentazione elettrica, utilizzare solo un cavo con le stesse caratteristiche (H05 VV-F - 3x1, 5 mmq).

Nel caso in cui non sia necessario utilizzare la spina Schuko è possibile tagliare il cavo di alimentazione e collegarlo ad una spina differente o direttamente al collegamento dell'alimentazione. Si prega di fare attenzione a collegare correttamente le polarità.

- ..... L → fase (cavo marrone)
- ..... N → neutro (cavo blu)

Prevedere un interruttore bipolare vicino all'apparecchio per consentire l'isolamento dell'apparecchio.

 **ATTENZIONE: PRIMA DI OPERARE SUL TERMOSTATO, ACCERTARSI CHE L'ALIMENTAZIONE ELETTRICA SIA COMPLETAMENTE SCOLLEGATA.**

 El aparato debe estar conectado a una fuente de alimentación monofásica (asegúrese de conectar el voltaje correcto: 120 V o 230 V según la etiqueta de datos del aparato) y a una buena conexión a tierra.

 **EL CONSTRUCTOR NO ACEPTA RESPONSABILIDAD POR POSIBLES DAÑOS O LESIONES CAUSADOS POR LA FALTA DE CONEXIÓN A TIERRA DEL EQUIPO.**

El aparato está equipado con un cable de alimentación con enchufe Schuko. Conecte el cable de alimentación de acuerdo con las normas de cableado vigentes en el país donde está instalado el aparato. En caso de sustitución del cable de alimentación, utilice únicamente un cable con las mismas características (H05 VV-F - 3x1, 5 mmq).

En el caso en que no se necesite utilizar el enchufe Schuko, es posible cortar el cable de alimentación y conectarlo a otro enchufe o directamente a la conexión de la fuente de alimentación. Tenga cuidado de conectar las polaridades correctamente.

- ..... L → fase (cable marrón)
- ..... N → neutro (cable azul)

Disponer un interruptor bipolare cerca del aparato para permitir el aislamiento del aparato.

 **ATENCIÓN: ANTES DE TRABAJAR EN EL TERMOSTATO, ASEGÚRESE DE QUE LA FUENTE DE ALIMENTACIÓN ELÉCTRICA ESTÉ COMPLETAMENTE DESCONECTADA.**

 The appliance must be connected to a single-phase power supply (please make sure to connect the correct voltage: 120V or 230V according to the data label on the appliance) and to a good earth connection.

 **THE MANUFACTURER DENIES ANY RESPONSIBILITY FOR POSSIBLE DAMAGES OR INJURIES CAUSED BY THE LACK OF EARTH CONNECTION OF THE EQUIPMENT**

The appliance is equipped with a power cable with Schuko plug. Connect the power cable in compliance with the wiring regulations in force in the country where the appliance is installed. In case of replacement of the power supply cable, use only a cable with the same characteristics (H05 VV-F - 3x1, 5 mmq).

If the Schuko plug is not needed, it is possible to cut the power cable and connect it to a different plug or directly to the power supply connection. Please be careful to connect the polarities correctly.

- .....L → live (brown cable)
- .....N → neutral (blue cable)

Foresee a bipolar switch near the appliance to allow the isolation of the appliance.

 **ATTENTION: BEFORE WORKING ON THE THERMOSTAT, MAKE SURE THAT THE ELECTRIC POWER SUPPLY IS COMPLETELY DISCONNECTED.**

 L'appareil doit être connecté à une alimentation monophasée (s'assurer de connecter la tension correcte: 120V ou 230V selon l'étiquette de données sur l'appareil) et à une bonne mise à la terre.

 **LE FABRICANT DECLINE TOUTE RESPONSABILITÉ POUR LES DOMMAGES OU BLESSURES POSSIBLES CAUSÉS PAR LE MANQUE DE MISE À LA TERRE DE L'ÉQUIPEMENT.**

L'appareil est équipé d'un câble d'alimentation avec prise Schuko. Brancher le câble d'alimentation conformément aux réglementations de câblage en vigueur dans le pays où l'appareil est installé. En cas de remplacement du câble d'alimentation, utiliser uniquement un câble ayant les mêmes caractéristiques (H05 VV-F - 3x1, 5 mmq).

Dans le cas il n'est pas nécessaire d'utiliser la prise Schuko, il est possible de couper le câble d'alimentation et de le connecter à une autre prise ou directement à l'alimentation électrique. Veiller à bien connecter les polarités.

- .....L → phase (câble marron)
- .....N → neutre (câble bleu)

Prévoir un interrupteur bipolaire à proximité de l'appareil pour permettre l'isolation de l'appareil.

 **ATTENTION: AVANT D'INTERVENIR SUR LE THERMOSTAT, S'ASSURER QUE L'ALIMENTATION ÉLECTRIQUE EST COMPLÈTEMENT DÉBRANCHÉE.**

**10. ISTRUZIONI PER L'USO**  
**INSTRUCTIONS FOR USE**  
**INSTRUCCIONES DE USO**  
**INSTRUCTIONS D'UTILISATION**

La resistenza elettrica è dotata di un termostato che ha la seguente duplice funzione:

1. impostazione della temperatura: (T – vedere figura), interrompendo l'alimentazione elettrica alla resistenza elettrica dell'apparecchio quando viene raggiunta la temperatura preimpostata (è possibile regolare il termostato tra 13 °C e 65 °C, secondo le necessità dell'utente).
2. Sicurezza: interrompendo l'alimentazione elettrica alla resistenza elettrica quando, in caso di cattivo funzionamento dell'apparecchio, la temperatura dell'acqua immagazzinata raggiunge i 83 °C. Per avviare nuovamente l'apparecchio, è necessario un intervento manuale (riarmo manuale). In questo caso, attenersi alla seguente procedura:
  - a) scollegare l'alimentazione elettrica
  - b) rimuovere il cappuccio di protezione della resistenza elettrica
  - c) premere il pulsante di reset posizionato sul termostato (R – vedere figura)
  - d) mettere il coperchio di protezione della resistenza elettrica
  - e) ripristinare l'alimentazione elettrica

**ATTENZIONE: COLLEGARE L'ALIMENTAZIONE ALLA RESISTENZA ELETTRICA SOLO QUANDO IL SERBATOIO È PIENO D'ACQUA. L'ELEMENTO RISCALDANTE NON È ADATTO PER UN FUNZIONAMENTO A SECCO.**

La resistencia eléctrica está equipada con un termostato que tiene la siguiente función dual:

1. Ajuste de temperatura: (T – ver figura), cortando la alimentación a la resistencia eléctrica del aparato cuando se alcanza la temperatura preestablecida (es posible regular el termostato entre 13 °C y 65 °C, según las necesidades del usuario).
2. Seguridad: cortando el suministro eléctrico a la resistencia eléctrica cuando, en caso de mal funcionamiento del aparato, la temperatura del agua almacenada alcanza los 83 °C. Para volver a poner en marcha el aparato, se requiere una intervención manual (reset manual). En tal caso, siga los siguientes pasos:
  - a) desconectar la fuente de alimentación
  - b) quitar la tapa de protección de resistencia eléctrica
  - c) presionar el botón de reinicio ubicado en el termostato (R – ver figura)
  - d) poner la tapa para proteger el calentador eléctrico
  - e) conectar la alimentación eléctrica

**ATENCIÓN: CONECTE LA FUENTE DE ALIMENTACIÓN A LA RESISTENCIA ELÉCTRICA SÓLO CUANDO EL TANQUE ESTÉ LLENO DE AGUA. EL ELEMENTO DE CALEFACCIÓN NO ES ADECUADO PARA FUNCIONAMIENTO EN SECO.**

The electric heating element is equipped with a thermostat that has the following dual function:

1. temperature setting: (T – see picture), cutting off the power supply to the electric heating element of the appliance when the preset temperature is reached (it is possible to adjust the thermostat between 13 °C and 65 °C, according to the user's needs).
2. Safety: cutting off the power supply to the electric heating element when, in the event of a failure of the appliance, the temperature of the stored water reaches 83 °C. To start the appliance again, a manual intervention is required (manual reset). In this case, follow these steps:
  - a) disconnect the power supply
  - b) remove the electric heating element protection cap
  - c) press the reset button located on the thermostat (R – see picture)
  - d) put the cover to protect the electric heating element
  - e) restore the power supply

**ATTENTION: CONNECT THE POWER SUPPLY TO THE ELECTRIC HEATING ELEMENT ONLY WHEN THE TANK IS FULL OF WATER. THE HEATING ELEMENT IS NOT SUITABLE FOR DRY OPERATION.**

La résistance électrique est équipée d'un thermostat qui a la double fonction suivante :

1. Réglage de la température : (T – voir figure), coupant l'alimentation de la résistance électrique de l'appareil lorsque la température prééglée est atteinte (il est possible de régler le thermostat entre 13 °C et 65 °C, selon les besoins de l'utilisateur).
2. Sécurité : en coupant l'alimentation électrique de la résistance électrique lorsque, en cas de dysfonctionnement de l'appareil, la température de l'eau stockée atteint 83 °C. Pour redémarrer l'appareil, une intervention manuelle est nécessaire (réarmement manuel). Dans ce cas, procéder comme suit:
  - a) débrancher l'alimentation électrique
  - b) Retirer le capuchon de protection de résistance électrique
  - c) Appuyer sur le bouton de réinitialisation situé sur le thermostat (R – voir figure)
  - d) Mettre le couvercle pour protéger la résistance électrique
  - e) rétablir l'alimentation électrique

**ATTENTION : BRANCHER L'ALIMENTATION À LA RÉSISTANCE ÉLECTRIQUE UNIQUEMENT LORSQUE LE RÉSERVOIR EST PLEIN D'EAU. L'ÉLÉMENT CHAUFFANT NE CONVIENT PAS AU FONCTIONNEMENT À SEC.**

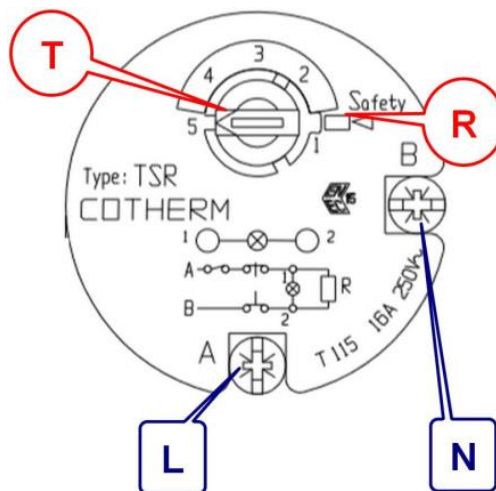

## 11. ■ ■ MANUTENZIONE DELL'APPARECCHIO

### ■ ■ MAINTENANCE OF THE APPLIANCE

### ■ ■ MANTENIMIENTO DEL APARATO

### ■ ■ MAINTENANCE DE L'APPAREIL

Per mantenere sicuro il funzionamento dell'apparecchio e preservarne al meglio la componentistica, è consigliato controllo periodico (frequenza almeno annuale) da parte di un tecnico specializzato.

Operazioni consigliate durante il controllo periodico:

- verificare serraggio e tenuta delle connessioni idrauliche
- verificare il serraggio della valvola di sicurezza e verificare che non sia otturata per eventuali depositi di calcare
- verifica del fissaggio (sostituire le viti di fissaggio nel caso siano usurate)
- efficienza dell'impianto elettrico e della messa a terra e condizioni del cavo di alimentazione (se danneggiato deve essere sostituito dal produttore, servizio tecnico autorizzato o da personale qualificato)
- sostituire l'anodo di magnesio almeno una volta all'anno, pena decadenza della garanzia

 **ATTENZIONE: IL GELO PUÒ PROVOCARE DANNI PERMANENTI ALL'APPARECCHIO.**

**NEL CASO IN CUI L'APPARECCHIO NON SIA UTILIZZATO DURANTE LA STAGIONE FREDDA SVUOTARE COMPLETAMENTE L'APPARECCHIO (UTILIZZARE IL RUBINETTO DI SCARICO D vedere figura)**

Per la pulizia del mantello esterno utilizzare esclusivamente acqua e sapone neutro. È raccomandabile utilizzare un panno morbido avendo cura di risciacquare e asciugare accuratamente. Non si devono utilizzare prodotti contenenti sostanze abrasive.

Para mantener el funcionamiento del dispositivo seguro y preservar sus componentes de la mejor manera posible, se recomienda una revisión periódica por parte de un técnico especializado al menos una vez al año.

Acciones recomendadas durante la verificación periódica:

- controlar el ajuste y el sellado de las conexiones hidráulicas
- controlar el ajuste de la válvula de seguridad y comprobar que no esté bloqueada por depósitos de cal
- verificar la fijación (sustituir los tornillos si están gastados)
- verificar el rendimiento del sistema eléctrico y puesta a tierra y estado del cable de alimentación (si está dañado debe ser reemplazado por el técnico especializado)
- reemplace el ánodo de magnesio por lo menos una vez al año, en caso contrario la garantía caducará

 **ATENCIÓN: LA HELADA PUEDE CAUSAR DAÑOS PERMANENTES AL APARATO. SI EL APARATO NO SE UTILIZA DURANTE LA TEMPORADA DE FRÍO, VACIAR COMPLETAMENTE EL APARATO (UTILIZAR EL GRIFO DE DRENAJE D ver figura)**

Para limpiar la parte exterior utilice únicamente agua y jabón neutro. Se recomienda utilizar un paño suave para enjuagar y secar bien. No se deben utilizar productos que contengan sustancias abrasivas.

 To keep the operation of the device safe and preserve its components in the best possible way, a periodic check by a specialized technician is recommended at least once a year.

Recommended actions during the periodic check:

- check tightening and sealing of hydraulic connections
- check tightening of the safety valve and check that it is not blocked by any limescale deposits
- check the fastening (replace the fastening screws if they are worn)
- efficiency of the electrical system and earthing and condition of the power cable (if damaged, it must be replaced by a specialized technician)
- replace the magnesium anode at least once a year, otherwise the guarantee will lapse

 **ATTENTION: FROST CAN CAUSE PERMANENT DAMAGE TO THE APPLIANCE. IF THE APPLIANCE IS NOT USED DURING THE COLD SEASON, COMPLETELY EMPTY THE APPLIANCE (USE THE DRAIN TAP D see picture)**

To clean the outer casing use only water and neutral soap. It is recommended to use a soft cloth taking care to rinse and dry thoroughly. Products containing abrasive substances must not be used.

Pour assurer le fonctionnement de l'appareil en toute sécurité et préserver ses composants de la meilleure façon possible, un contrôle périodique par un technicien spécialisé est recommandé au moins une fois par an.

Actions recommandées lors du contrôle périodique:

- vérifier le serrage et l'étanchéité des raccords hydrauliques
- vérifier le serrage de la soupape de sécurité et vérifier qu'elle n'est pas obstruée par des dépôts calcaires
- vérifier la fixation (remplacer les vis de fixation si elles sont usées)
- vérifier l'efficacité du système électrique, de la mise à la terre et l'état du câble d'alimentation (s'il est endommagé, il doit être remplacé par un technicien spécialisé)
- remplacer l'anode en magnésium au moins une fois par an, sous peine de déchéance de la garantie

 **ATTENTION: LE GEL PEUT CAUSER DES DOMMAGES PERMANENTS À L'APPAREIL. SI L'APPAREIL N'EST PAS UTILISÉ PENDANT LA SAISON FROIDE, VIDER L'APPAREIL COMPLÈTEMENT (UTILISER LE ROBINET DE VIDANGE D voir figure)**

Pour nettoyer le boîtier extérieur utiliser uniquement de l'eau et du savon neutre. Il est recommandé d'utiliser un chiffon doux en prenant soin de bien rincer et sécher. Les produits contenant des substances abrasives ne doivent pas être utilisés.

**12.**  **GARANZIA**  
 **WARRANTY**  
 **GARANTIE**  
 **GARANTIE**

 Le condizioni di garanzia sono valide a condizione che siano rispettate le istruzioni di installazione contenute in questo opuscolo. La garanzia decorre dalla data di produzione stampata sull'etichetta dati dell'apparecchio ed ha una durata di 36 mesi. Per motivi di sicurezza e per la validità della garanzia è obbligatorio usare solo parti di ricambio originali.

 The warranty conditions are valid provided that the installation instructions contained in this brochure are observed. The warranty starts from the production date printed on the data label of the appliance and has a duration of 36 months. For safety reasons and for the validity of the guarantee, it is mandatory to use only original spare parts.

 Las condiciones de garantía son válidas con la condición que se respeten las instrucciones para la instalación presentes en este folleto. La garantía empieza desde la fecha de producción grabada en la etiqueta del aparato y dura 36 meses. Por motivos de seguridad y para la vigencia de la garantía es obligatorio usar solo repuestos originales.

 Les conditions de garantie sont valables à condition que les instructions d'installation contenues dans cette notice soient respectées. La garantie commence à partir de la date de production imprimée sur la plaque signalétique de l'appareil et a une durée de 36 mois. Pour des raisons de sécurité et pour la validité de la garantie, il est obligatoire de n'utiliser que des pièces de rechange d'origine.

13.  **PRINCIPALI RICAMBI**  
 **MAIN SPARE PARTS**  
 **PRINCIPALES REPUESTOS**  
 **PRINCIPALES PIÈCES DE RECHANGE**

pos.	cod.		BQ2205	BQ2208	BQ2212
1	0-0618	staffa di fissaggio <i>fixing bracket</i>	2	2	2
2	020-0052	cuffiotto resistenza <i>electric heating element protection cap</i>	1	1	1
3	050-0024	anodo di magnesio <i>magnesium anode</i>	1	1	1
4	100-0086	guarnizione <i>seal</i>	1	1	1
5	130-0057	rubinetto di scarico <i>drain tap</i>	1	1	1
6	130-0059	valvola sicurezza pressione e temperatura <i>pressure and temperature relief valve</i>	1	1	1
7	130-0099	raccordo diritto maschio - 1/2 x 18 <i>1/2 x 18 straight male fitting</i>	4	4	4
8	140-0001	pressacavo PG 9 <i>cable gland PG 9</i>	1	1	1
9	280-0014	resistenza elettrica - 230 V - 550 W <i>230 V - 550 W electric heating element</i>	1	-	-
9	280-0015	resistenza elettrica - 230 V - 850 W <i>230 V - 850 W electric heating element</i>	-	1	-
9	280-0016	resistenza elettrica - 230 V - 1250 W <i>230 V - 1250 W electric heating element</i>	-	-	1
10	280-0042	termostato <i>thermostat</i>	1	1	1
11	900-0135	cavo alimentazione <i>supply cable</i>	1	1	1

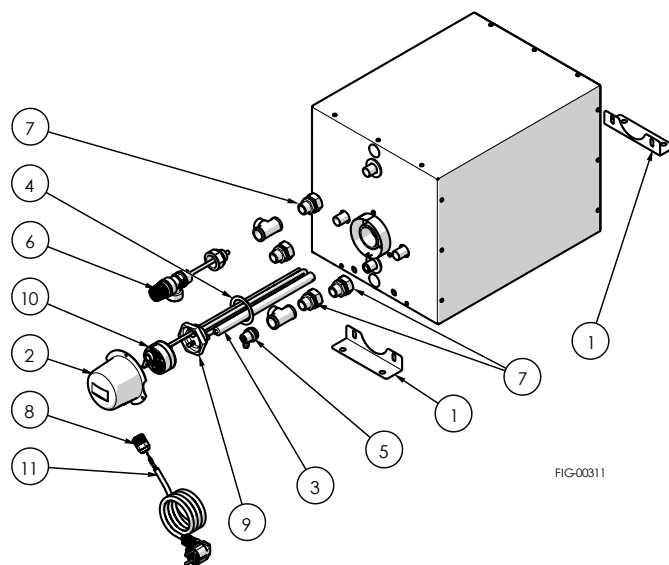

## **ATI DI MARIANI SRL**

Via E. Mattei 461  
Zona Ind. Torre del Moro n°4  
47522 Cesena (FC) - ITALIA

Tel. +int-39-0547 609711

[www.nautica.atimariani.it](http://www.nautica.atimariani.it)  
[nautica@atimariani.it](mailto:nautica@atimariani.it)



Il produttore non è responsabile per errori o imprecisioni in questo libretto. Si riserva inoltre il diritto di modificare i propri modelli (in qualsiasi momento e senza alcun preavviso) per esigenze tecniche o di marketing, al fine di perseguire la qualità dei propri prodotti.



The manufacturer is not responsible for mistakes or inaccuracy in this booklet. It also reserves the right to change its models (in any time and without any prior notice) due to technical or marketing needing, in order to pursue the quality of its products.



El fabricante no es responsable por errores o inexactitudes en este folleto. También se reserva el derecho de cambiar sus modelos (en cualquier momento y sin previo aviso) por necesidades técnicas o de marketing, con el fin de obtener mayor calidad de sus productos.



Le fabricant n'est pas responsable des erreurs ou inexactitudes dans ce livret. Il se réserve également le droit de modifier ses modèles (à tout moment et sans préavis) pour des raisons techniques ou marketing, afin de poursuivre la qualité de ses produits.