



REMOTE CONTROL

INSTALLATION OPERATION MAINTENANCE

USER MANUAL



THIS MANUAL MUST BE KEPT ON BOARD AT ALL TIMES

Via Philips 5, 20900 Monza (MI), Italy
Tel: +39 039 2001973-936 - Fax: +39 039 2004299
Email: contact@lofrans.com - www.lofrans.com

Contents

Section	Title	Page
1	DESCRIPTION	4
2	TECHNICAL SPECIFICATIONS	4
3	PRODUCT REFERENCES	5
4	PACKAGING CONTENTS	5
5	GENERAL DIMENSIONS	6
6	INSTALLATION AND CONNECTIONS	6
7	SET UP	7
8	RESETTING	8
9	ADDING ADDITIONAL TRANSMITTERS AND RECEIVERS	8
10	EXAMPLES OF USE	9
11	REPLACING BATTERIES	9
12	TROUBLE SHOOTING	10
13	WORLDWIDE DISTRIBUTION	10
14	WARRANTY	11
15	ELECTRICAL WIRING CONNECTION	12

It is strongly advised that only qualified marine electricians should install this equipment. For any boat requiring official classification, bodies of approval should also be consulted at the earliest opportunity. In any case, all other bodies, governmental or otherwise, should be contacted to ensure conformity with legal regulations relating to the boat in question.

**IT IS ESSENTIAL TO READ THE FOLLOWING MANUAL CAREFULLY
BEFORE INSTALLING THIS EQUIPMENT**

1- DESCRIPTION

The Max Power radio remote control is designed to work with Max Power's entire range of tunnel and retractable thrusters. The remote control can also be used to operate any other onboard equipment for which it may be useful.

2- TECHNICAL SPECIFICATIONS

	TRANSMITTER	RECEIVER
Power supply	2 lithium batteries 3V (CR2430)	12 to 24V DC
Power consumption in standby	0A	22mA @ 12V DC
Power consumption when in use	50 mA @ 6V DC max	110 mA @ 12V DC max
Operating temperature	-15°C / +55°C	-15°C / +55°C
Dimensions (mm)	114 x 60 x 22	125 x 78 x 21
Weight (g)	80g	110g
Frequency (MHz)	868 (EU regulation) 915 (US regulation)	868 (EU regulation) 915 (US regulation)

This product is in compliance with the following regulations:

R & TTE Directive EN 300 220-1 V2.1.1 (2006-04) EN 300 220-2 V.2.1.1 (2006-04) EN 300 220-2 V2.1.2, EN 301 489-3, ETSI EN 301 489-3 V1.4.1 (02)	EN 60945 EN 60945 (02) EN 60950-1: 2006; CEI 60950-1: 2005 FCC ID: W6Z (Transmitter) IC: 8220A (Transmitter) IC: 8220A (Receiver)
--	--

This device complies with part 15 of the FCC rules. Operation is subject to the following two conditions (1) This device may not cause harmful interference and (2) this device must accept any interference received including interference that may cause undesired operation.

3- PRODUCT REFERENCES

The remote control is available as a kit including both the transmitter and the receiver. Additional receivers and spare transmitters are also available independently.

EU and US regulations require different frequencies. For this reason both the transmitter and the receiver are available in 2 different frequencies.

- Each transmitter includes its batteries (2 x CR2430)
- Each receiver includes its connectors

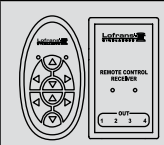
868 MHz (EU regulation)		312976
915 MHz (US regulation)		312977

4- PACKAGING CONTENTS

The Remote Control is delivered with:

312976 (EU) 312977 (US) KIT REMOTE CONTROL
<ul style="list-style-type: none">✓ 1 transmitter✓ 1 receiver✓ 2 connectors✓ 2 brackets + 2 screws✓ 1 lanyard✓ 1 user manual

* Receiver and transmitter are available as individual spare parts.

Please contact Lofrans customer support at www.lofrans.com for any assistance.

5- GENERAL DIMENSIONS

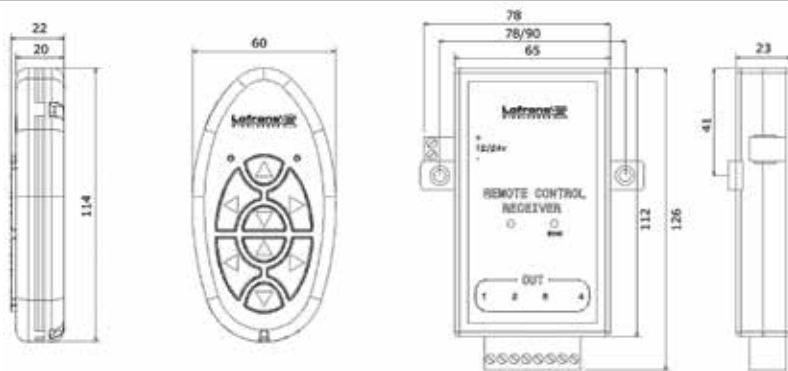

All dimensions are in mm

6- INSTALLATION AND CONNECTIONS









1. Turn OFF the power supply to the thruster or the equipment being connected
2. Fit the receiver in a dry and accessible area (preferably not in the bilge). If necessary, use the 2 brackets supplied by removing the 2 screws on the back of the receiver and replacing them with the 2 other screws supplied (M2.5 x 16). For a thruster, an ideal location is behind one of the thruster control panels.
3. Connect the receiver to the power supply (12 or 24V DC)
4. **CAUTION: ENSURE THE POLARITIES ARE RESPECTED. Reversing the polarity of the receiver WILL irreversibly damage the receiver's circuits.**
5. **Protect the positive supply cable of the receiver by means of a 1A fuse.**
6. **The receiver already has an integrated protection.**
7. Connect the 4 outputs of the receiver (1, 2, 3 & 4) to the equipment that is to be operated. In the case of a bow thruster or windlass, see the annexed diagrams for precise instructions.
8. **NB: The outputs (1, 2, 3 & 4) are isolated volt free contacts with a load switching capacity of up to 24V and 5A**
9. Follow the set up instructions (cf. chapter 7)

CAUTION:

Fit the receiver as far as possible from large metallic objects, electric motors or high current cables.
Please connect the radio receiver's power supply to the yacht's main service battery bank.

- 6 The battery bank powering the receiver must be sufficiently charged (refer to the battery supplier's recommendations).

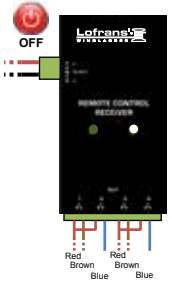
7- SET-UP

<p>1</p>   <p>Red Brown Blue Blue</p>	<p>2</p>  <p>ON</p> <p>Red Brown Blue Blue</p>	<p>3</p>  <p>Red Brown Blue Blue</p>
<p>Connect the receiver to the power supply 12/24V</p>	<p>Turn the power supply ON → The LED flashes once</p>	<p>Gently press the SYNC button (just once) using a small screwdriver → The LED lights up</p>
<p>4</p>   <p>Red Brown Blue Blue</p> <p>*</p>	<p>5</p>  <p>OFF</p> <p>Red Brown Blue Blue</p>	<p>6</p>  <p>* Authorised combinations</p>
<p>To activate 2 commands simultaneously press the 2 buttons* to be activated → The LED will flash. These commands are now activated and paired to outputs 1 & 2</p>	<p>Turn the receiver OFF (for 5 seconds)</p>	<p>To activate other commands return to step 2. Outputs will be activated in their numerical order in pairs.</p>

Note: Each receiver can handle a maximum of 4 channels: 2 sets of 2 buttons corresponding to receiver outputs (1, 2, 3 and 4). Should the full 8 channels of the transmitter be required, a second receiver is needed.

8- RESETTING

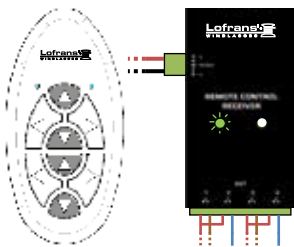

To reset a receiver, gently press the **SYNC** button using a small screwdriver

→ **The LED lights up.**

Press the 4 up-down buttons **simultaneously**

→ **The LED will flash**

The receiver's memory has been cleared.

Turn the receiver's power supply OFF, wait 5 seconds and then return to **step 2** (cf. Chapter 7 Set-up)

9- ADDING ADDITIONNAL TRANSMITTERS AND RECEIVERS

Transmitters

To add an extra transmitter, follow the instructions from **step 2** (cf. Chapter 7 Set-up) and configure the additional remote control.

NB: In case of error or doubt concerning the configuration, clear the receiver's memory (cf. Chapter 8) and start from the beginning. This will require the reconfiguration of all remote controls.

Each complete maximised system (ie. 2 receivers and all 8 channels used on the transmitter) can only include 2 transmitters.

Receiver

Go to **step 2** (cf. Chapter 7 Set-up) and follow the instructions as normal.





* Receiver and transmitter are available as individual spare parts.

Please contact Lofrans customer support at www.lofrans.com for any assistance.

10- EXAMPLES OF USE

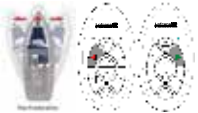
Using the remote control with a Max Power thruster or a windlass

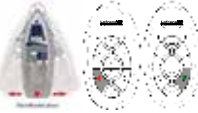
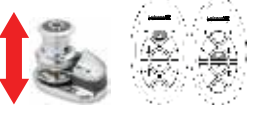
1. Turn the thruster / windlass ON (via its control panel).
2. Turn the receiver ON if the power supply is not the same as the thruster / windlass.
3. Use the remote control to operate the thruster / windlass (see below instructions).

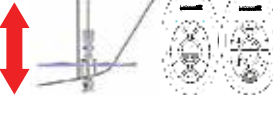
	<p>BOW THRUSTER PORT / STARBOARD</p>		<p>BOW AND STERN THRUSTER PORT / STARBOARD</p>
	<p>STERN THRUSTER PORT / STARBOARD</p>		<p>WINDLASS UP / DOWN</p>
	<p>BOW AND STERN THRUSTER STARBOARD / STARBOARD</p>		<p>RETRACTABLE THRUSTER UP / DOWN</p>

11- REPLACING THE BATTERIES

⚠ CAUTION: ENSURE THAT THE EQUIPMENT'S POWER SUPPLY IS SWITCHED OFF BEFORE REPLACING THE BATTERIES IN ORDER TO AVOID ACCIDENTAL ACTIVATION OF THE EQUIPMENT.

⚠ CAUTION: RISK OF EXPLOSION IF BATTERY IS REPLACED BY AN INCORRECT TYPE. DISPOSE OF USED BATTERIES ACCORDING TO THE INSTRUCTIONS.

1. Remove the 4 screws from the back of the transmitter
2. Remove the back part of the transmitter
3. Remove the 2 batteries on the electronic control card
4. Replace the 2 batteries with 2 new **CR2430** batteries. **Ensure the polarities are respected.**
5. Replace the back part of the transmitter and **GENTLY TIGHTEN THE SCREWS** whilst ensuring that the rubber membrane is correctly positioned so that the product remains waterproof.

IT IS RECOMMENDED TO CHANGE THE BATTERIES AT THE START OF EACH SEASON

12- TROUBLE SHOOTING

Before contacting Lofrans, please consult the following trouble shooting guide.

Problem	Check
The receiver's LED doesn't light up	Check the power supply to the receiver
The transmitter's LEDs do not light up	Check the transmitter's batteries and the polarity
The remote control doesn't work	Check the connections of the receiver's relay outputs
The remote control works intermittently	Check the voltage of the battery bank powering the radio receiver

13- WORLDWIDE DISTRIBUTION

To locate the nearest Lofrans distributor, please consult the section "Worldwide Distribution" on our website: www.lofrans.com

14- WARRANTY

Warranty coverage

The equipment is guaranteed to be free of manufacturing and operation defects under normal usage conditions for a period of **2 years** from the date of purchase by the end user (upon production of sales receipt or other proof of purchase). This warranty is transferable to subsequent owners of this equipment during the period of coverage.

If the remote control is used for any purpose other than leisure boat equipment, the warranty is limited to **6 months**.

ANY MODIFICATION OF THE PRODUCT WILL RESULT IN THE ANNULMENT OF THE WARRANTY

Warranty Exclusions

- The manufacturer's warranty **does not cover**:
- Damage caused by modifications or an installation contrary to published specifications
- Damage due to repairs performed by an unauthorized service centre
- Damage due to lack of normal maintenance
- Damage due to water
- Cost of hauling the boat
- Parts replaced due to normal wear and tear
- Repairs performed without the knowledge of the manufacturer (please contact dealer to receive Repair Authorization Number)
- Cost of travel to and from the job site
- Repairs due to an incorrect installation
- Repairs carried out by the end user on the equipment
- Tampering of equipment by the end user
- Cost of economic loss, including injury to any person, damage to property, loss of income or profit, communication, lodging, inconvenience
- Consequential damage due to failure, including those arising from collision with other vessels or objects

ELECTRICAL WIRING CONNECTION

Examples given for:

- Max Power Thruster CT60/CT80
- Lofrans Windlass (3 terminals motor)

For other makes and models of equipment please refer to the manufacturer's wiring diagram

CONTROL BOX AND REMOTE CONTROL RECEIVER SUPPLY:
To be connected to separate battery bank (advised)

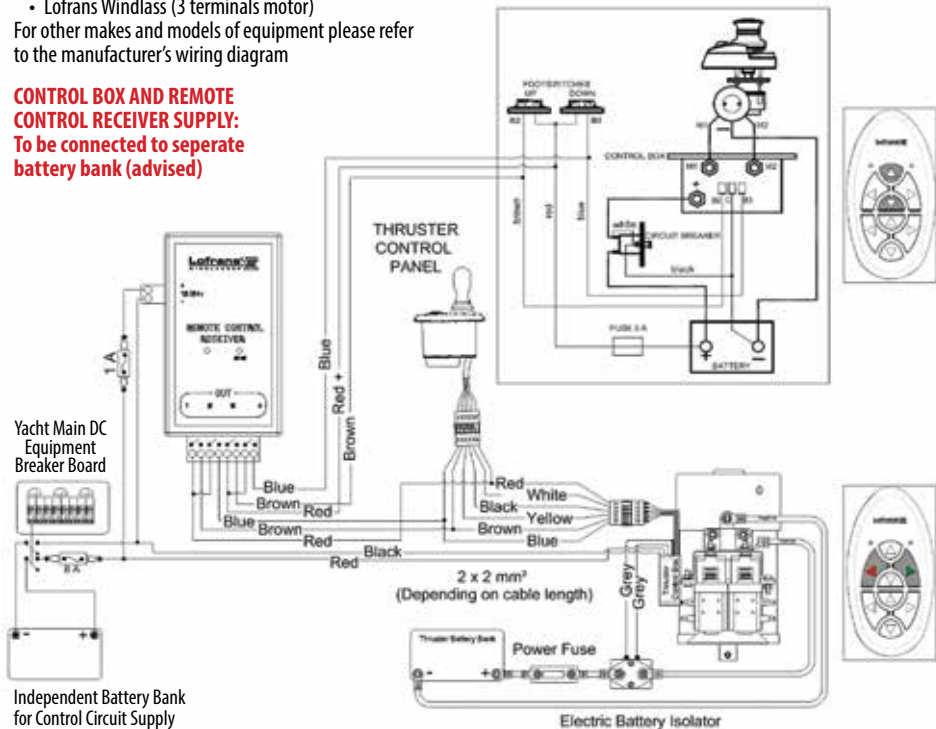

Independent Battery Bank
for Control Circuit Supply

ELECTRICAL WIRING CONNECTION

Examples given for:

- Max Power Bow Thruster CT60/CT80
- Max Power Stern Thruster CT60/CT80
- Lofrans Windlass (3 terminals motor)

For other makes and models of equipment please refer to the manufacturer's wiring diagram

CONTROL BOX AND REMOTE CONTROL RECEIVER SUPPLY: To be connected to separate battery bank (advised)

Yacht Main DC
Equipment
Breaker Board

Independent Battery Bank
for Control Circuit Supply

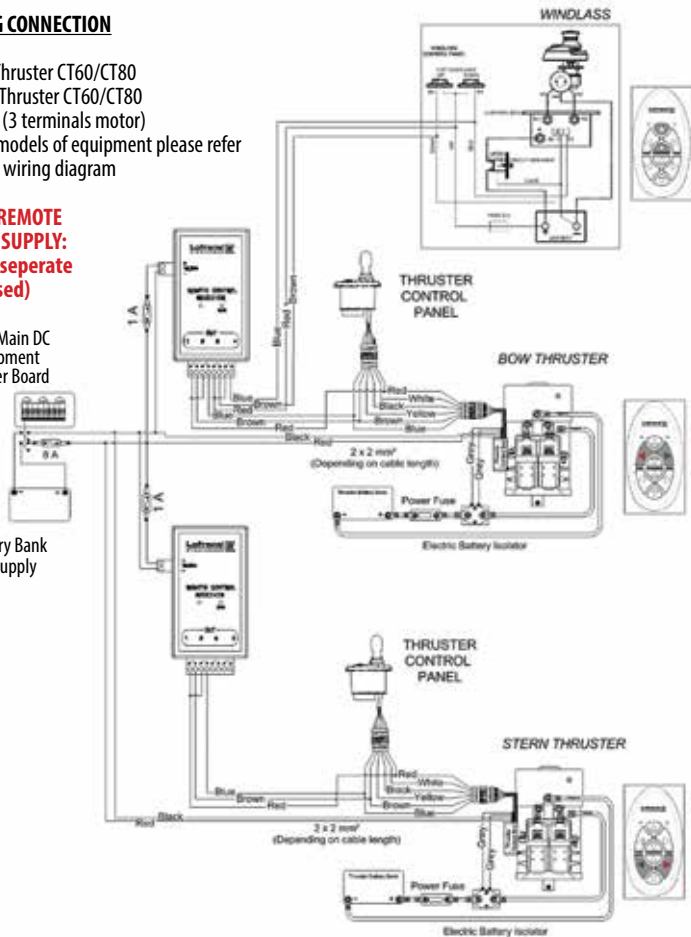

ELECTRICAL WIRING CONNECTION

Examples given for:

- Max Power Thruster Compact Retract

For other makes and models of equipment please refer to the manufacturer's wiring diagram

CONTROL BOX AND REMOTE CONTROL RECEIVER SUPPLY:
To be connected to separate battery bank (advised)

WARNING

It is important to use only 12v Power Supply for the Thruster Control System.
(Control Box and Electric Battery Isolator)

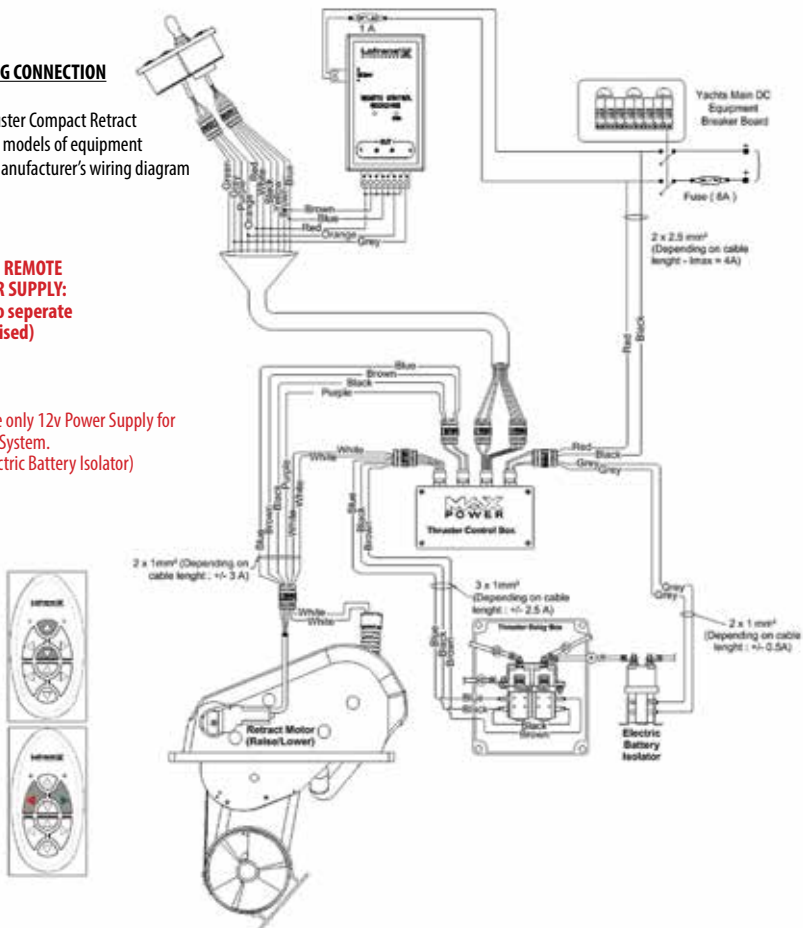

TWO THRUSTERS SET-UP PROCEDURE

RESET RECEIVERS

RESETTING

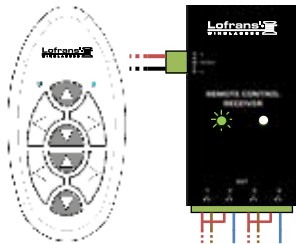

To reset a receiver, gently press the **SYNC** button using a small screwdriver

→ **The LED lights up.**

Press the 4 up-down buttons **simultaneously**

→ **The LED will flash**

The receiver's memory has been cleared.

Turn the receiver's power supply OFF, wait 5 seconds.

PROGRAM FIRST RECEIVER

TWO THRUSTERS SET-UP (1st RECEIVER)

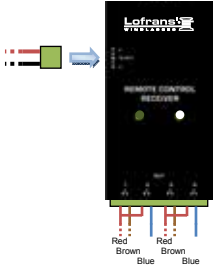
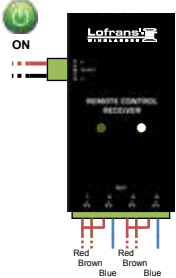
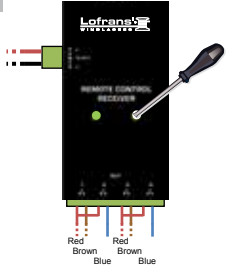
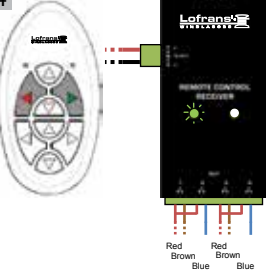
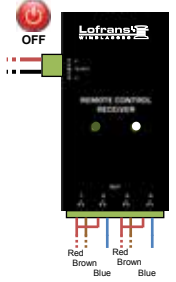
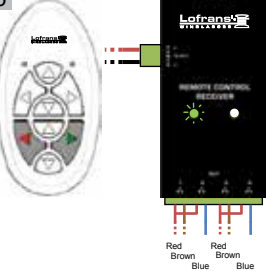
<p>1</p> 	<p>2</p> 	<p>3</p> 
<p>Connect the receiver to the power supply 12/24V</p>	<p>Turn the power supply ON → The LED flashes once</p>	<p>Gently press the SYNC button (just once) using a small screwdriver → The LED lights up</p>
<p>4</p> 	<p>5</p> 	<p>6</p> 
<p>To activate 2 commands simultaneously press the 2 buttons* to be activated → The LED will flash. These commands are now activated and paired to outputs 1 & 2</p>	<p>Turn the receiver OFF (for 5 seconds)</p>	<p>To activate other commands return to step 2. Outputs will be activated in their numerical order in pairs.</p>

PROGRAM FIRST RECEIVER

TWO THRUSTERS SET-UP (2nd RECEIVER)

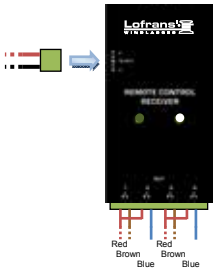
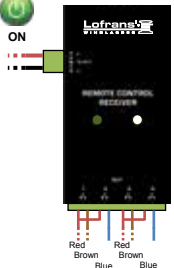
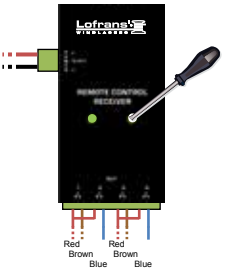
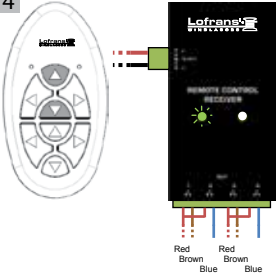
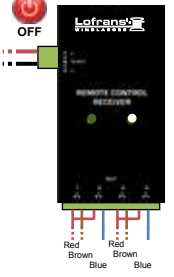
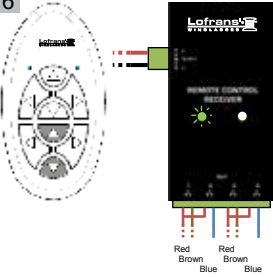
<p>1</p> 	<p>2</p> 	<p>3</p> 
<p>Connect the receiver to the power supply 12/24V</p>	<p>Turn the power supply ON → The LED flashes once</p>	<p>Gently press the SYNC button (just once) using a small screwdriver → The LED lights up</p>
<p>4</p> 	<p>5</p> 	<p>6</p> 
<p>To activate 2 commands simultaneously press the 2 buttons* to be activated → The LED will flash. These commands are now activated and paired to outputs 1 & 2</p>	<p>Turn the receiver OFF (for 5 seconds)</p>	<p>To activate other commands return to step 2. Outputs will be activated in their numerical order in pairs.</p>



Via Philips 5, 20900 Monza (MI), Italy
Tel: +39 039 2001973-936 - Fax: +39 039 2004299
Email: contact@lofrans.com - www.lofrans.com